

Qoltec®

Product name: AGM Battery

Trade name: AGM battery | 12V | 200Ah

Model: 53069



Specifications

Nominal Voltage	12V	
Rated capacity (10 hour rate)	200Ah	
Dimensions	Length	522±2mm(20.55inch)
	Width	238±2mm(9.37inch)
	Height	218±2mm(8.58inch)
	Total Height	222±2mm(8.74inch)
Approx. Weight	59.5kg (131.2lbs)±3%	

Outer dimensions (mm)

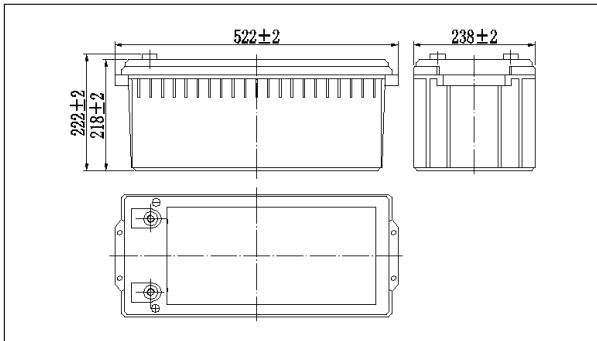

Terminal Type (mm)

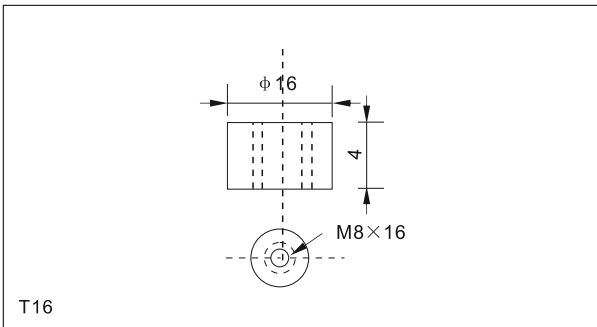

Characteristics

Capacity (25°C)	10HR(10.8V)	200Ah
	3HR(10.8V)	150Ah
	1HR(10.5V)	108Ah
Terminal type		T16
Internal resistance (Fully charged, 25°C)		Approx. 3.3m Ω
Capacity affected by temperature (10HR)	40°C	102%
	25°C	100%
	0°C	85%
	-15°C	65%
Self-discharge (25°C)	3 months	Remaining Capacity: 91%
	6 months	Remaining Capacity: 82%
	12 month	Remaining Capacity: 65%
Nominal operating temperature		25°C ± 3°C (77°F ± 5°F)
Operating temperature range	Discharge	-15°C~50°C (5°F~122°F)
	Charge	-10°C~50°C (14°F~122°F)
	Storage	-20°C~50°C (-4°F~122°F)
Float charging voltage(25°C)		13.50 to 13.80V Temperature compensation: -18mV/°C
Cyclic charging voltage(25°C)		14.40 to 14.70V Temperature compensation: -30mV/°C
Maximum charging current		40A
Maximum discharge current		1400A(5 sec.)
Designed floating life(20°C)		12years

Construction

Component	Positive plate	Negative plate	Container	Cover	Separator	Electrolyte	Safety valve	Terminal
Raw material	Lead dioxide	Lead	ABS	ABS	AGM	Gel	Rubber	Copper

Constant Current Discharge Characteristics Unit:A(25°C, 77°F)

F.V/Time	15min	30min	60min	2h	3h	4h	5h	6h	8h	10h	20h
9.60V	314	190	118	73.1	52.0	40.8	34.7	30.6	24.5	20.4	10.8
9.90V	306	186	116	72.6	51.7	40.6	34.5	30.4	24.3	20.3	10.8
10.2V	295	181	113	72.0	51.4	40.3	34.2	30.2	24.2	20.3	10.7
10.5V	285	176	109	70.9	51.0	40.0	34.0	30.0	24.0	20.1	10.7
10.8V	270	170	106	69.1	50.0	38.8	33.0	29.1	23.3	20.0	10.6

Constant Power Discharge Characteristics Unit:W(25°C, 77°F)

F.V/Time	15min	30min	60min	2h	3h	4h	5h	6h	8h	10h	20h
9.60V	3443	2133	1341	846	612	480	410	362	291	243	129
9.90V	3361	2090	1321	841	608	477	408	360	289	243	129
10.2V	3237	2026	1287	834	604	474	405	357	287	242	129
10.5V	3127	1977	1247	821	600	470	402	355	285	240	128
10.8V	2961	1905	1207	800	588	456	390	344	277	239	127

Note: The above characteristics data can be obtained within three charge or discharge cycles.

● Discharge characteristics(25°C)

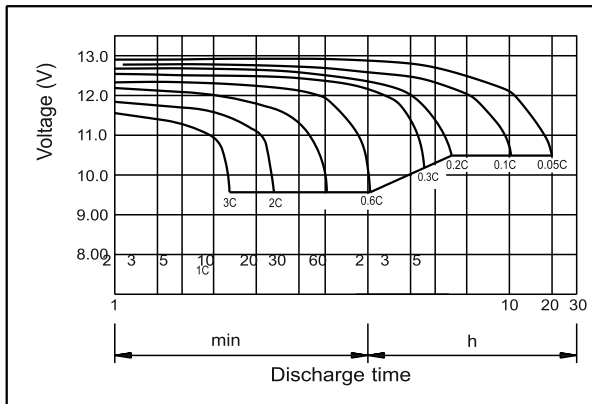

● Charging characteristics (25°C)

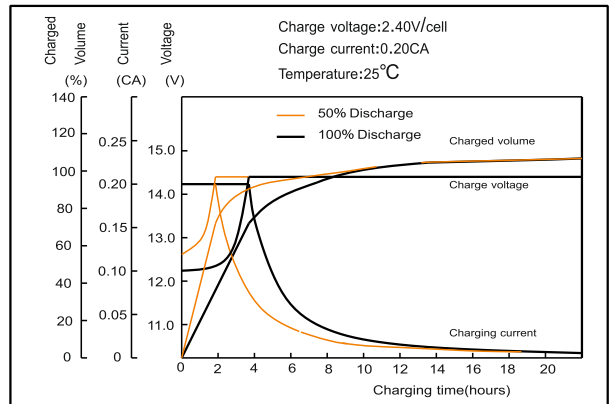

● Temperature effects on Capacity

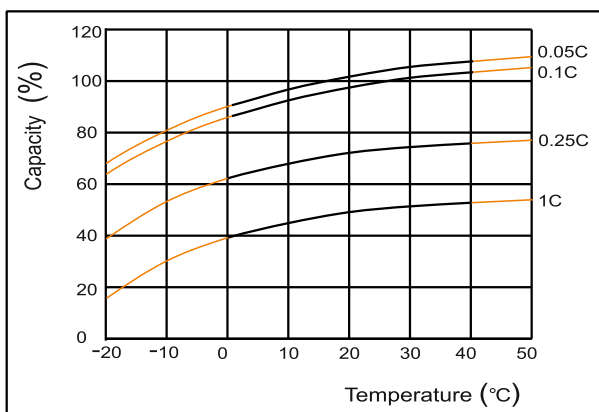

● Self-discharge characteristics

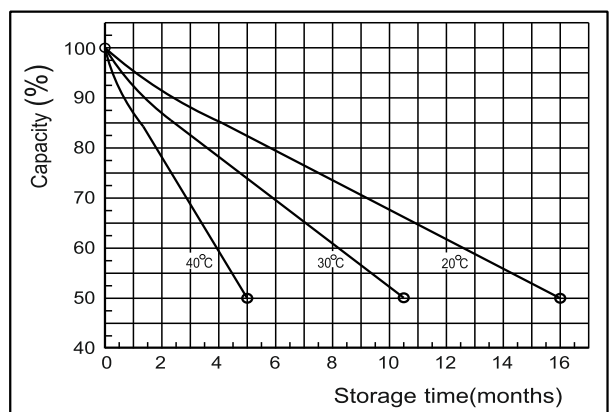

● Floating life on Temperature

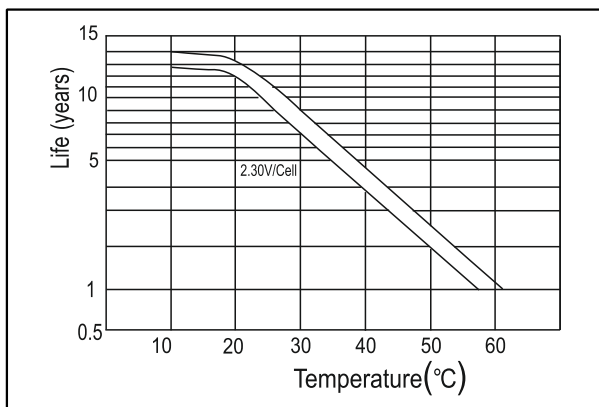

● Cycle life on D.O.D (25°C)

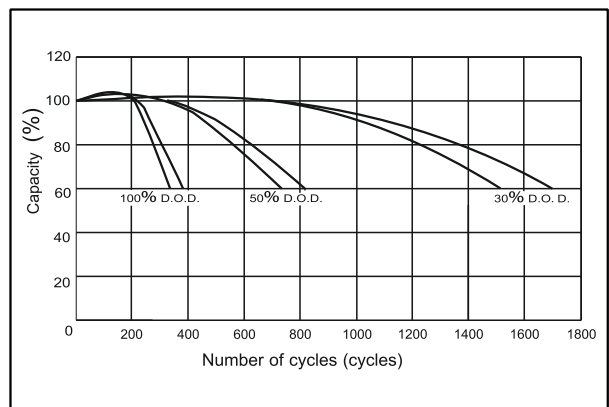

● The relationship for OCV and Capacity (25°C)

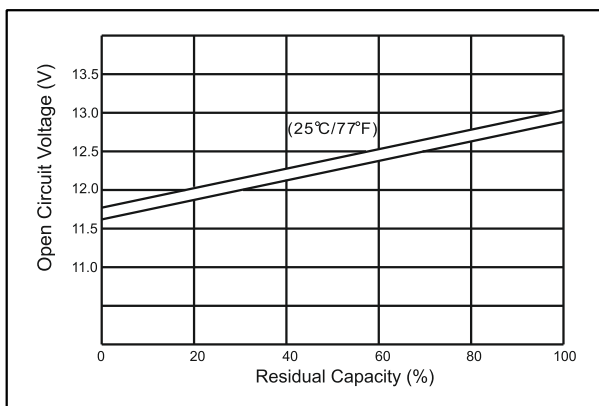

● The relationship for Charging voltage and Temperature

